



## Technical Data Sheet

### 3mm Silicon PIN Photodiode T-1

---

#### PD204-6B

#### Features

- Fast response time
- High photo sensitivity
- Small junction capacitance
- Pb free

#### Descriptions

- PD204-6B is a high speed and high sensitive PIN photodiode in a standard 3 $\Phi$  plastic package.  
The device is matched to infrared emitting diode.



#### Applications

- Automatic door sensor
- Copier
- Game machine

#### Device Selection Guide

LED Part No.	Chip	Lens Color
	Material	
PD	Silicon	Water clear

**Package Dimensions**

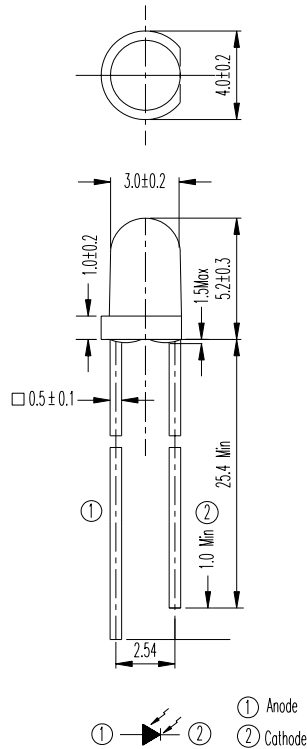

- Notes:** 1.All dimensions are in millimeters  
 2.Tolerances unless dimensions  $\pm 0.1$ mm

**Absolute Maximum Ratings (Ta=25°C)**

Parameter	Symbol	Rating	Units
Reverse Voltage	V <sub>R</sub>	32	V
Operating Temperature	T <sub>opr</sub>	-25 ~ +85	°C
Storage Temperature	T <sub>stg</sub>	-40 ~ +85	°C
Soldering Temperature	T <sub>sol</sub>	260	°C
Power Dissipation at(or below) 25°C Free Air Temperature	P <sub>c</sub>	150	mW

**Notes:** \*1:Soldering time  $\leq 5$  seconds.

**Electro-Optical Characteristics (Ta=25°C)**

Parameter	Symbol	Condition	Min	Typ	Max	Unit
Rang Of Spectral Bandwidth	$\lambda_{0.5}$	---	840	---	1100	nm
Wavelength Of Peak Sensitivity	$\lambda_p$	---	---	940	---	nm
Open-Circuit Voltage	$V_{OC}$	Ee=5mW/cm <sup>2</sup> $\lambda_p=940\text{nm}$	---	0.42	---	V
Short- Circuit Current	$I_{SC}$	Ee=1mW/cm <sup>2</sup> $\lambda_p=940\text{nm}$	---	3.0	---	$\mu\text{A}$
Reverse Light Current	$I_L$	Ee=1mW/cm <sup>2</sup> $\lambda_p=940\text{nm}$ $V_R=5\text{V}$	1.0	3.0	---	$\mu\text{A}$
Reverse Dark Current	$I_D$	Ee=0mW/cm <sup>2</sup> $V_R=10\text{V}$	---	---	10	nA
Reverse Breakdown Voltage	$B_{VR}$	Ee=0mW/cm <sup>2</sup> $I_R=100\mu\text{A}$	32	170	---	V
Total Capacitance	$C_t$	Ee=0mW/cm <sup>2</sup> $V_R=5\text{V}$ $f=1\text{MHz}$	---	5	---	pF
Rise Time	$t_r$	$V_R=10\text{V}$ $R_L=1000\Omega$	---	6	---	nS
Fall Time	$t_f$		---	6	---	

**Typical Electro-Optical Characteristics Curves**

Fig.1 Power Dissipation vs. Ambient Temperature

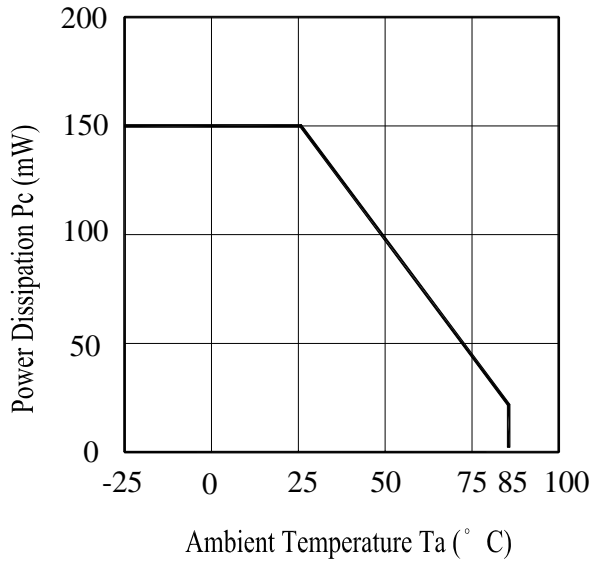

Fig.2 Spectral Sensitivity

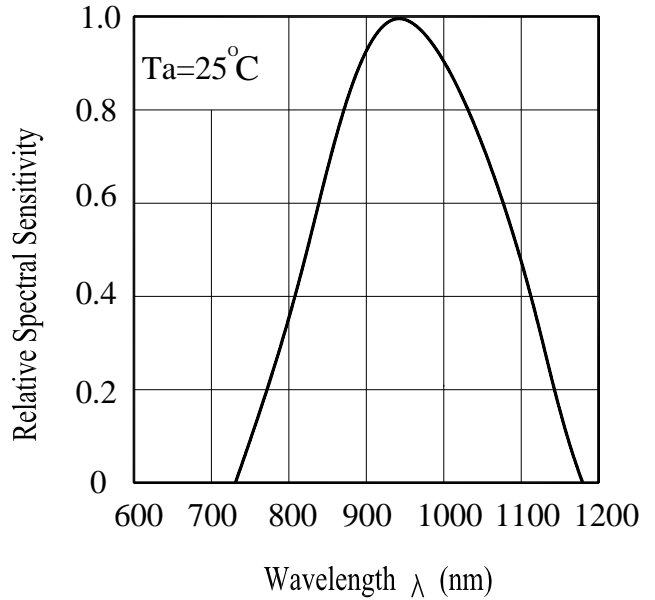

Fig.3 Dark Current vs. Ambient Temperature

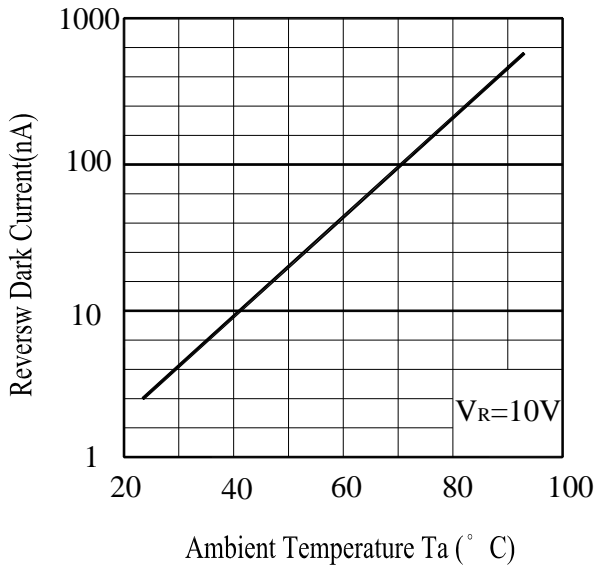
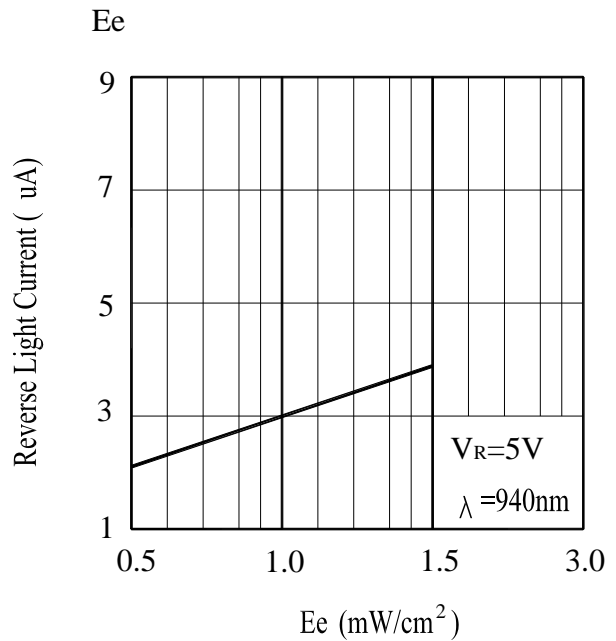

Fig. 4 Reverse Light Current vs. Ee



**Typical Electro-Optical Characteristics Curves**

Fig.5 Terminal Capacitance vs.

Reverse Voltage

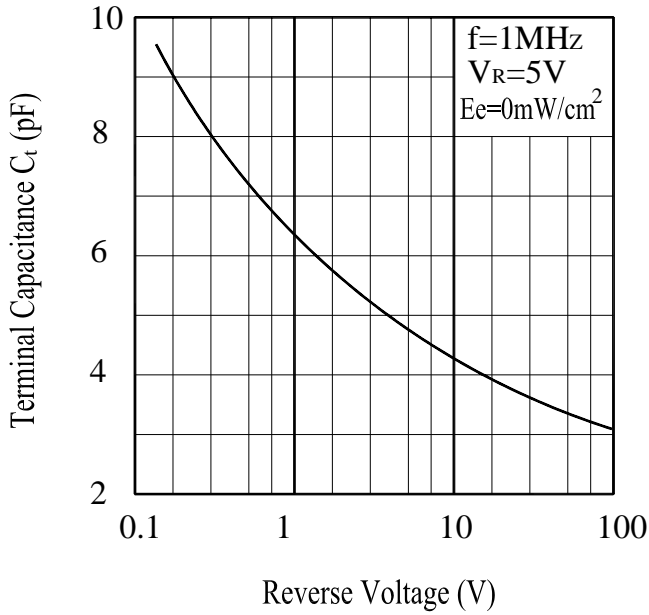
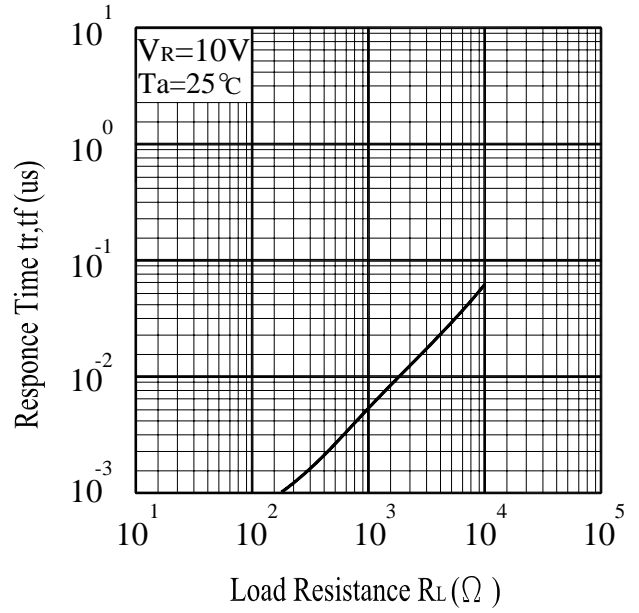

Fig.6 Response Time vs.

Load Resistance



**Reliability Test Item And Condition**

The reliability of products shall be satisfied with items listed below.

Confidence level : 90%

LTPD : 10%

NO.	Item	Test Conditions	Test Hours/ Cycles	Sample Sizes	Failure Judgement Criteria	Ac/Re
1	Solder Heat	TEMP. : 260°C±5°C	10secs	22pcs	$I_L \leq L \times 0.8$  L : Lower  Specification Limit	0/1
2	Temperature Cycle	H : +100°C    15mins ↑ 5mins ↓ L : -40°C    15mins	50Cycles	22pcs		0/1
3	Thermal Shock	H : +100°C    5mins ↑ 10secs ↓ L : -10°C    5mins	50Cycles	22pcs		0/1
4	High Temperature Storage	TEMP. : +100°C	1000hrs	22pcs		0/1
5	Low Temperature Storage	TEMP. : -40°C	1000hrs	22pcs		0/1
6	DC Operating Life	$V_R=5V$	1000hrs	22pcs		0/1
7	High Temperature/ High Humidity	85°C / 85% R.H	1000hrs	22pcs		0/1



### Packing Quantity Specification

- 1.1000PCS/1Bag , 4Bags/1Box
- 2.10Boxes/1Carton

### Label Form Specification

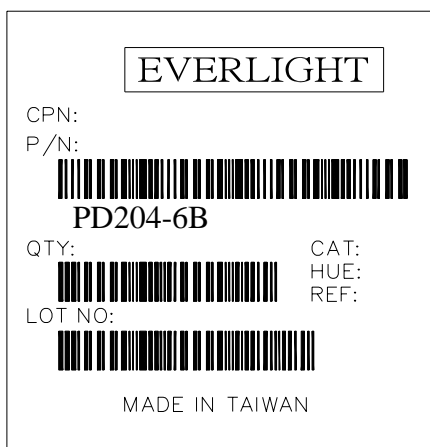

- CPN: Customer's Production Number
- P/N : Production Number
- QTY: Packing Quantity
- CAT: Ranks
- HUE: Peak Wavelength
- REF: Reference
- LOT No: Lot Number
- MADE IN TAIWAN: Production Place

### Notes

1. Above specification may be changed without notice. EVERLIGHT will reserve authority on material change for above specification.
2. When using this product, please observe the absolute maximum ratings and the instructions for using outlined in these specification sheets. EVERLIGHT assumes no responsibility for any damage resulting from use of the product which does not comply with the absolute maximum ratings and the instructions included in these specification sheets.
3. These specification sheets include materials protected under copyright of EVERLIGHT corporation. Please don't reproduce or cause anyone to reproduce them without EVERLIGHT's consent.

**EVERLIGHT ELECTRONICS CO., LTD.**      Tel: 886-2-2267-2000, 2267-9936  
Office: No 25, Lane 76, Sec 3, Chung Yang Rd,      Fax: 886-2267-6244, 2267-6189, 2267-6306  
Tucheng, Taipei 236, Taiwan, R.O.C      http:\\www.everlight.com